





Ipoli 07



Ipoli is a decorative multifunctional collection centered on the movement of playful swiveling heads atop a slender base. The collection draws inspiration from the design tradition of utilitarian, streamlined task lamps and office lighting, while enfolding Lambert & Fils' unique twist, both poetic and sturdy. Whether employed as a task light, ambient accent, or focal point, each piece will delight any space.

TYPE	Floor
CONSTRUCTION	Tumbled or powder coated aluminum body, head and cover plate Frosted opal acrylic lens Vinyl cord
SPECIFICATIONS	Power consumption: 8W Colour temperature: fixed 2200K fixed 2700K Lumen output: TBD Colour rendering index: ≥ 90 CRI Colour consistency: 3 SDCM Expected lifetime: $\geq 50\ 000$ h
CONTROL	100-240V touch dimmer only
CORD LENGTH	70" / 178 cm
WEIGHT	3.7lb / 1.7kg
CERTIFICATIONS	     IP20
WARRANTY	2 years

NOTES

- Dimensions are approximate and may vary slightly

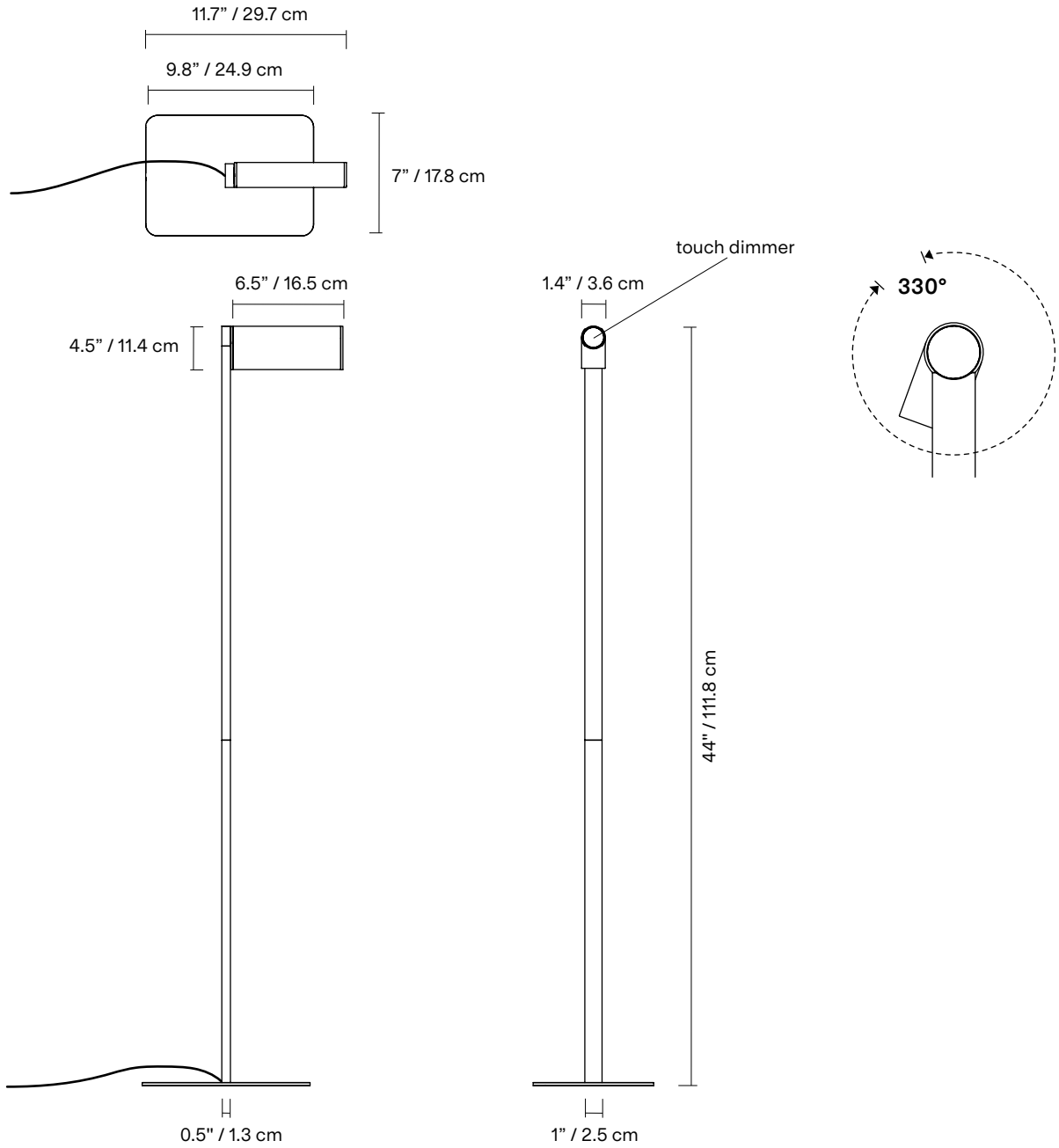

FINISH



BG
Textured
beige



BK
Textured
black



PP
Textured
poppy



TA
Tumbled
aluminum

NOTES

- LED may only be changed by Lambert & Fils or other authorized personnel
- Not protected against liquids (refer to IP20)
- Additional charges for modifications or for special orders
- Please refer to maintenance sheet on our website for cleaning instructions



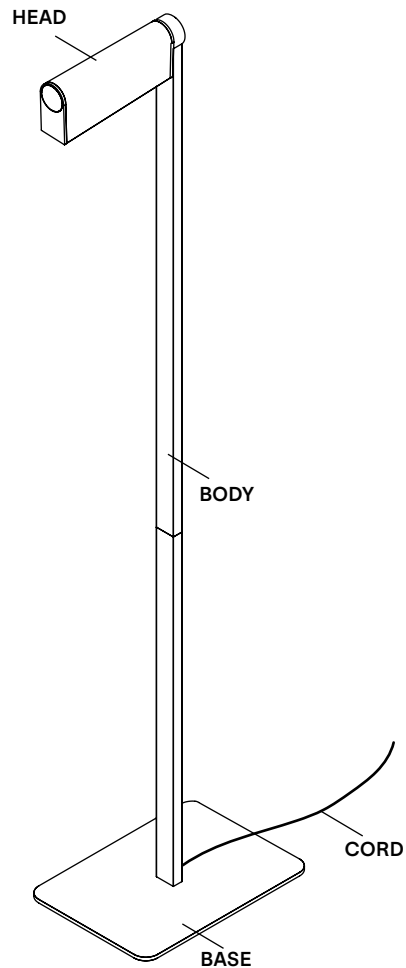

LAMP ANATOMY



Ipoli 08



Ipoli is a decorative multifunctional collection centered on the movement of playful swiveling heads atop a slender base. The collection draws inspiration from the design tradition of utilitarian, streamlined task lamps and office lighting, while enfolding Lambert & Fils' unique twist, both poetic and sturdy. Whether employed as a task light, ambient accent, or focal point, each piece will delight any space.

TYPE	Floor
CONSTRUCTION	Tumbled or powder coated aluminum body, head and cover plate Frosted opal acrylic lens Vinyl cord
SPECIFICATIONS	Power consumption: 8W Colour temperature: fixed 2200K fixed 2700K Lumen output: NA Colour rendering index: ≥ 90 CRI Colour consistency: 3 SDCM Expected lifetime: $\geq 50\ 000$ h
CONTROL	100-240V touch dimmer only
CORD LENGTH	70" / 178 cm
WEIGHT	4.5lb / 2kg
CERTIFICATIONS	     IP20
WARRANTY	2 years

NOTES

- Dimensions are approximate and may vary slightly

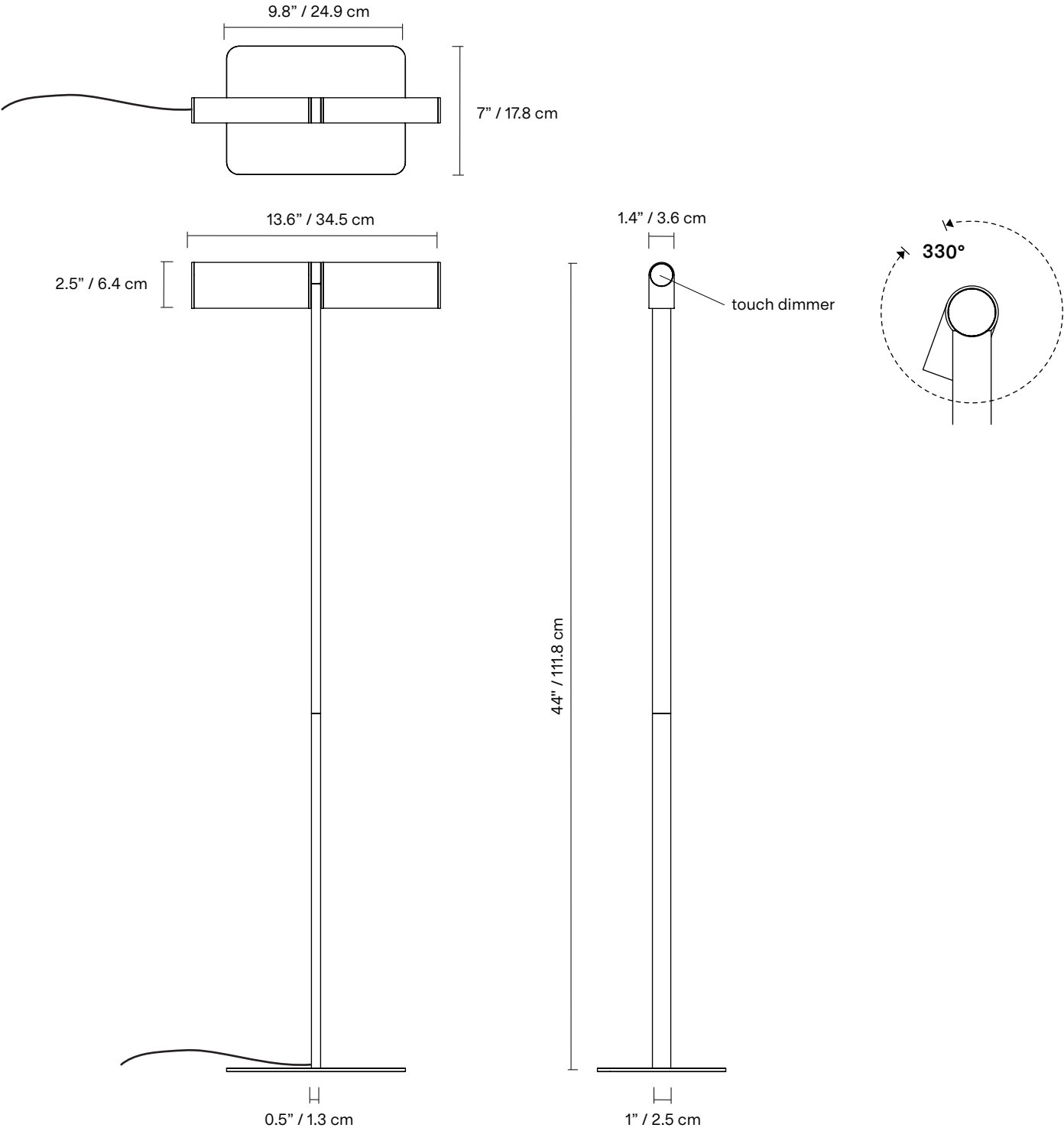

FINISH



BG
Textured
beige



BK
Textured
black



PP
Textured
poppy



TA
Tumbled
aluminum

NOTES

- LED may only be changed by Lambert & Fils or other authorized personnel
- Not protected against liquids (refer to IP20)
- Additional charges for modifications or for special orders
- Please refer to maintenance sheet on our website for cleaning instructions

LAMP ANATOMY

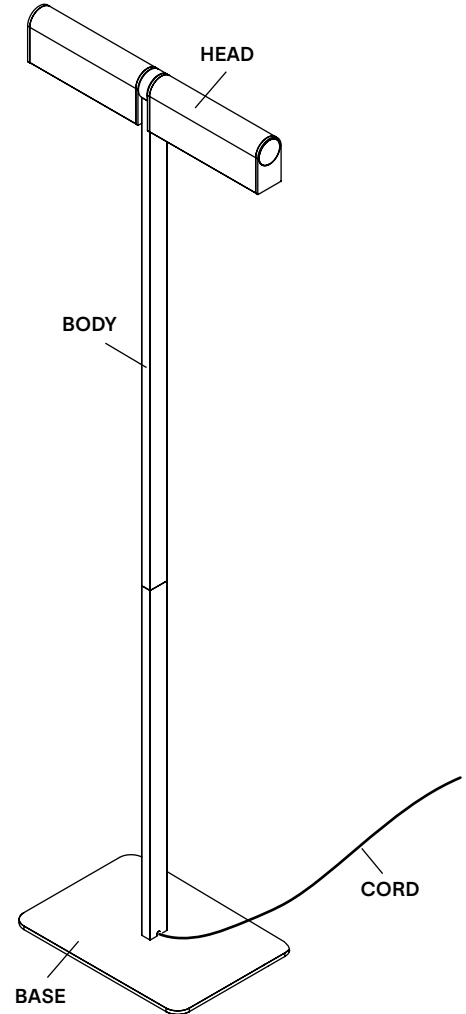

		Example	Fill with your selection
COLLECTION	IPO Ipoli	IPO	IPO
MODEL	08	08	08
CONFIGURATION	TO Touch dimmer	TO	TO
FINISH	BG Textured beige BK Textured black PP Textured poppy TA Tumbled aluminum CC Custom colour*	BG	
CORD	BK black	BK	BK
COLOUR TEMPERATURE (CCT)	F22 Fixed 2200K F27 Fixed 2700K	F22	
FULL SKU		IPO08TOBGBKF22	
		NOTES	

*Custom colour available upon request. Material library on website.

		Example	Fill with your selection
COLLECTION	IPO Ipoli	IPO	IPO
MODEL	07	07	07
CONFIGURATION	TO Touch dimmer	TO	TO
FINISH	BG Textured beige BK Textured black PP Textured poppy TA Tumbled aluminum CC Custom colour*	BG	
CORD	BK black	BK	BK
COLOUR TEMPERATURE (CCT)	F22 Fixed 2200K F27 Fixed 2700K	F22	
FULL SKU		IPO07TOBGBKF22	

NOTES

*Custom colour available upon request. Material library on website.