





Silo Atelier 01



The Silo collection inhabits many worlds at once, creating a striking metaphor for duality. Mysterious yet inviting, the true magic lies in how its rhythmic curves shape light and space around it. Made using custom aluminum extrusions, the modular uplight-downlight creates a theatrical yet sleek composition

TYPE	Suspension
CONSTRUCTION	Powder coated or mirror polished aluminum body Powder coated canopy Polycarbonate lens Polyurethane cord
SPECIFICATIONS	Source: LED array, integrated Power consumption: 50.8W, 44.5W (phase dimming CE) Colour temperature: 3000K 2700K dim to warm 3000K to 2200K dim to warm 2700K to 2200K Lumen output: 3000K -1621 lm downlight -1426 lm (phase dimming CE) -355 lm uplight -302 lm (phase dimming CE) 2700K -1545 lm downlight -1360 lm (phase dimming CE) -287 lm uplight -253 lm (phase dimming CE) Colour rendering index: ≥90 CRI Colour consistency: 3 SDCM Expected lifetime: ≥50 000h
CONTROL	120/277V on/off, 0-10V, or phase dimming (120V only) 220-240V: On/Off, Phase Dimming, DALI
CORD LENGTH	Custom length
STAINLESS STEEL CABLE	Custom length
WEIGHT	90 lb / 41 kg
CERTIFICATIONS	     IP20
WARRANTY	2 years

NOTES

- Luminaire total minimum height (ceiling to lowest point of luminaire) - 74" / 188 cm
- Luminaire total maximum height (ceiling to lowest point of luminaire) - variable, please specify
- Luminaire height is not adjustable on site (micro-adjustments only)
- Not available for slanted ceilings (see offset mounted)

SURFACE MOUNTED

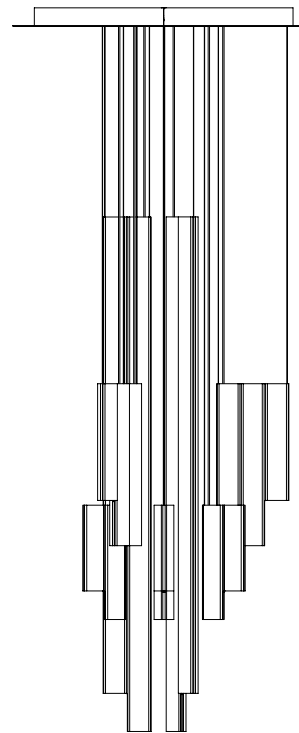
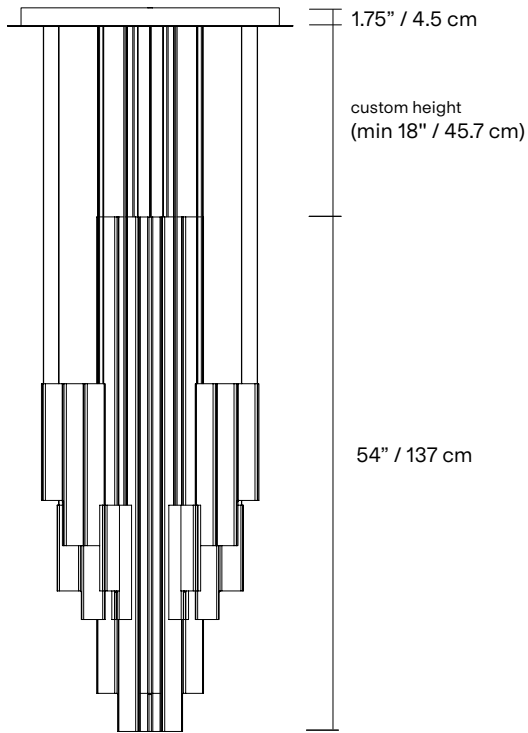
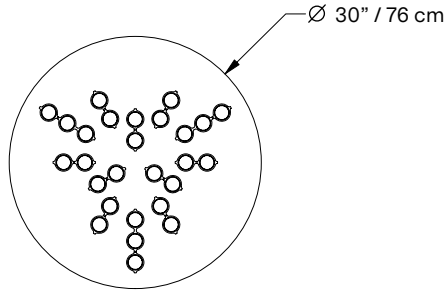

*dimensions are approximate and may vary slightly

Suggested installation

NOTES

- Luminaire total minimum height (ceiling to lowest point of luminaire) - 74" / 188 cm
- Luminaire total maximum height (ceiling to lowest point of luminaire) - variable, please specify
- Luminaire height is not adjustable on site (micro-adjustments only)
- Available for slanted ceiling - 45° or less
- Canopy total minimum height (ceiling to top of canopy) - 6" / 15 cm
- Canopy total maximum height (ceiling to top of canopy) - 120" / 305 cm (120" provided), contact Lambert & Fils for more options
- Canopy height is adjustable on site

OFFSET MOUNTED (for slanted ceiling or offset canopy)

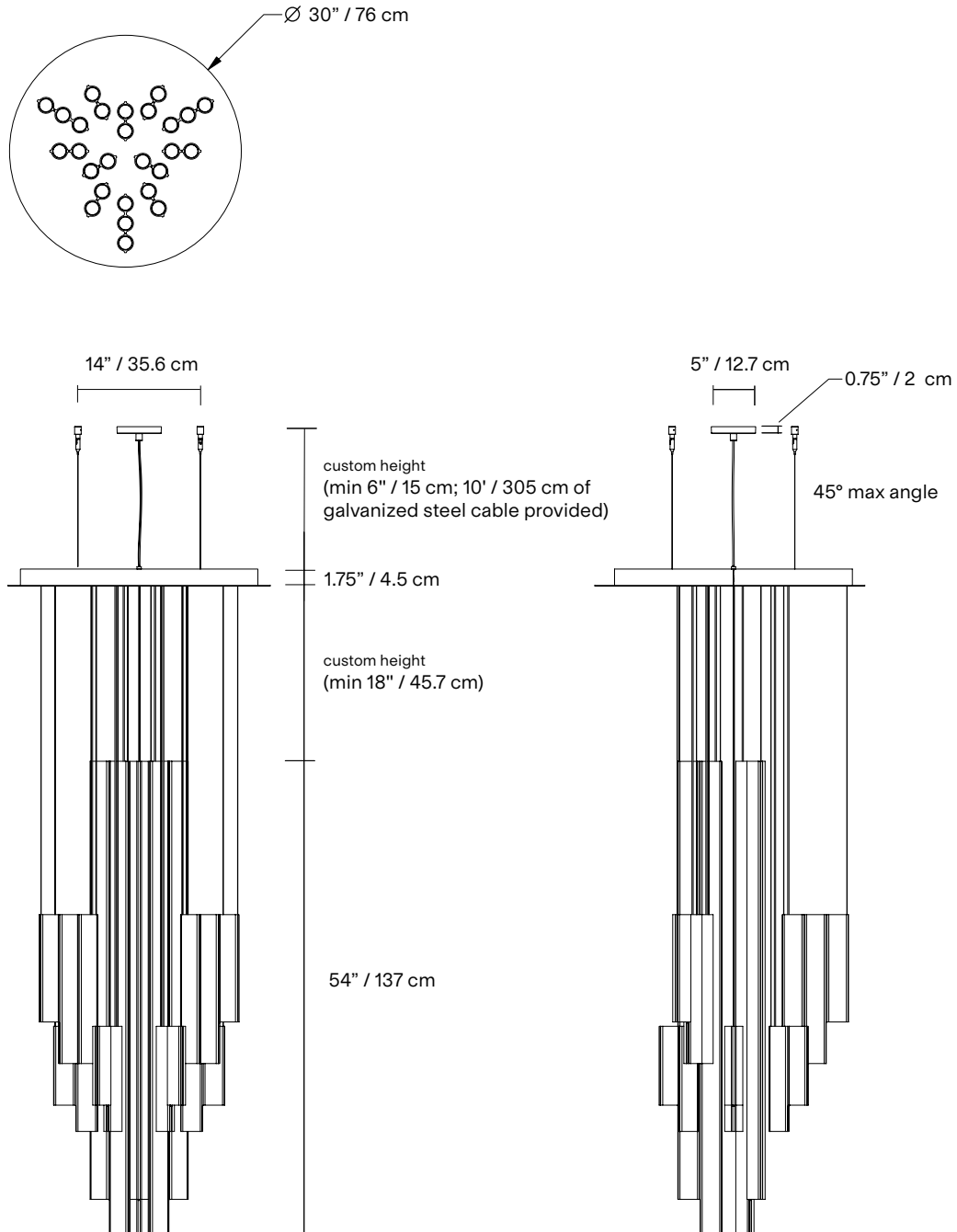

*dimensions are approximate and may vary slightly

FINISH



OB
Glossy
oxblood



MR
Mirror
polished
aluminum



BG
Textured
beige

CORD



BK
Black



WH
White



CU
Cumin

CANOPY AND MOUNTING SYSTEM

(offset canopy and anchors)



WH
Textured
white

CONFIGURATION

uplights

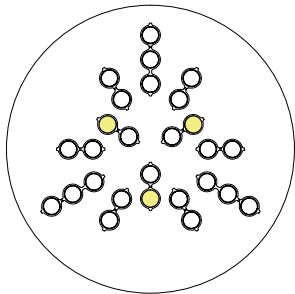

NOTES

- Must be installed by an electrician
- LED may only be changed by Lambert & Fils or other authorized personnel
- Not protected against liquids (refer to IP20)
- Additional charges for modifications or for special orders
- Please refer to maintenance sheet on our website for cleaning instructions

LAMP ANATOMY

(Offset canopy)

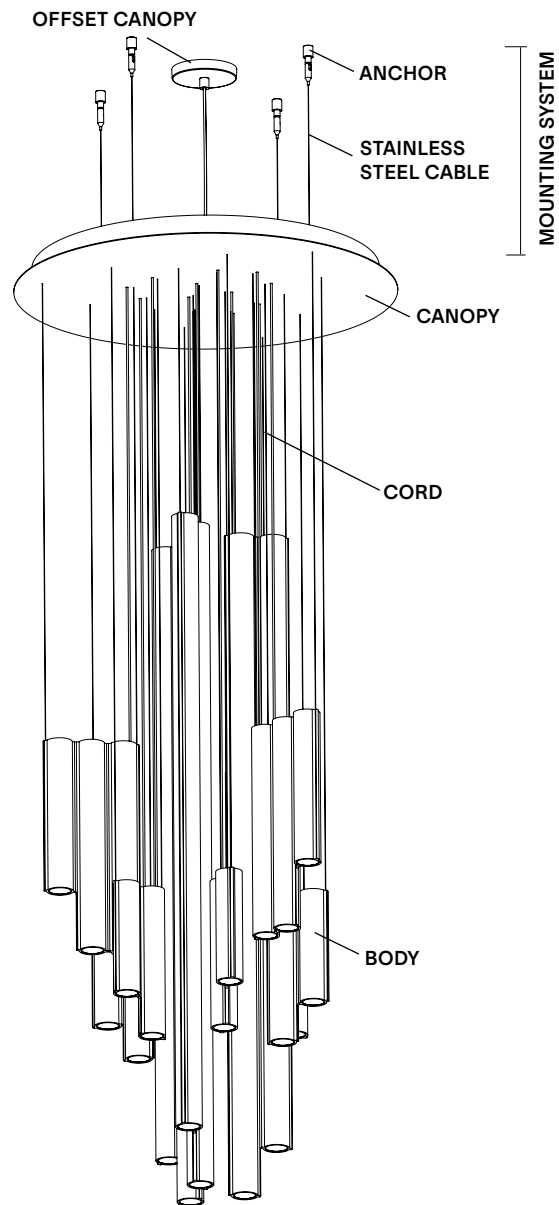
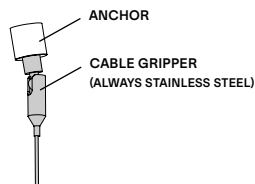

		Example	Fill with your selection
COLLECTION	SIL Silo	SIL	SIL
MODEL	51	51	51
BODIES	BG Textured beige OB Glossy oxblood MR Mirror polished aluminum CC Custom colour*	OB	
CORD	BK Black WH White CU Cumin	BK	
CANOPY	WH Textured white CC Custom colour*	WH	
MOUNTING TYPE	SM Surface mounted OS Offset mounted	SM	
MOUNTING TYPE FINISH**	WH Textured white CC Custom colour*	WH	
COLOUR TEMPERATURE (CCT)	WL Warm light (2700K) NL Neutral light (3000K) D27 Dim to warm (2700K-2200K) D30 Dim to warm (3000K-2200K) CCT Other CCT available upon request***	WL	
DIMMING	ZT 0-10V (120VAC only) PH Phase dimming DA DALI (220-240VAC only)	ZT	
FULL SKU		SIL51OBBKWHSMWLZT	

NOTES

*Custom colour available upon request. Material library on website.





**To choose only with offset mounted option.

***Specific CCT selection only available in 100k increments, from 2200K to 4000K inclusively and not available with Dim-to-Warm feature.

Silo Atelier 02



The Silo collection inhabits many worlds at once, creating a striking metaphor for duality. Mysterious yet inviting, the true magic lies in how its rhythmic curves shape light and space around it. Made using custom aluminum extrusions, the modular design creates a theatrical yet sleek composition.

TYPE	Suspension
CONSTRUCTION	Powder coated or mirror polished aluminum body Powder coated canopy Polycarbonate lens Polyurethane cord
SPECIFICATIONS	Source: LED array, integrated Power consumption: 44.5W Colour temperature: 3000K 2700K dim to warm 3000K to 2200K dim to warm 2700K to 2200K Lumen output: 3000K - 1591 lm downlight 2700K - 1517 lm downlight Colour rendering index: ≥90 CRI Colour consistency: 3 SDCM Expected lifetime: ≥50 000h
CONTROL	120/277V on/off, 0-10V, or phase dimming (120V only) 220-240V: On/Off, Phase Dimming, DALI
CORD LENGTH	Custom length
STAINLESS STEEL CABLE	Custom length
WEIGHT	72.5 lb / 32.9 kg
CERTIFICATIONS	     IP20
WARRANTY	2 years

Suggested installation

NOTES

- Luminaire total minimum height (ceiling to lowest point of luminaire) - 62" / 157 cm
- Luminaire total maximum height (ceiling to lowest point of luminaire) - variable, please specify
- Luminaire height is not adjustable on site (micro-adjustments only)
- Not available for slanted ceilings (see offset mounted)

SURFACE MOUNTED

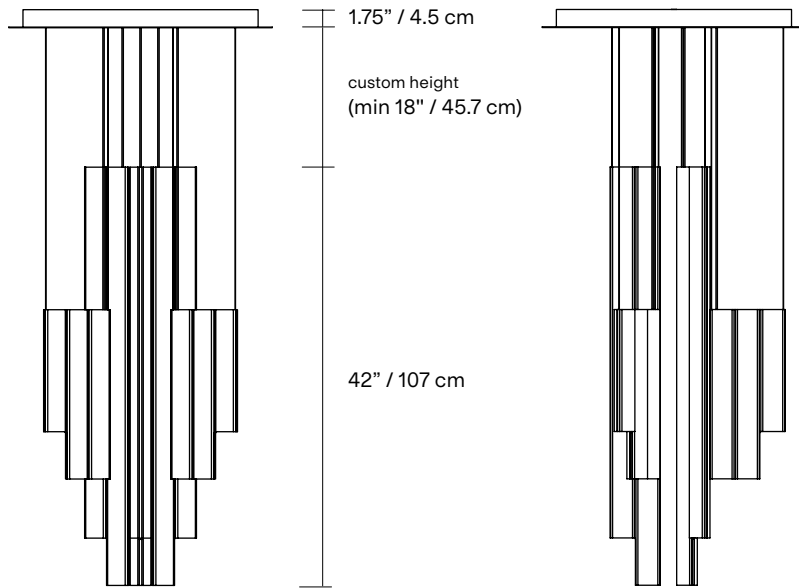
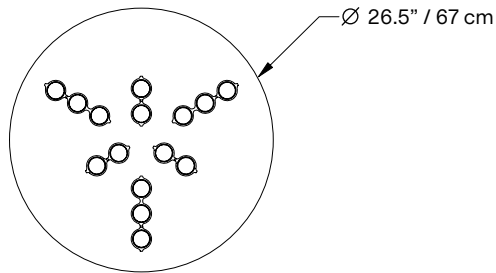

*dimensions are approximate and may vary slightly

NOTES

- Luminaire total minimum height (ceiling to lowest point of luminaire) - 62" / 157 cm
- Luminaire total maximum height (ceiling to lowest point of luminaire) - variable, please specify
- Luminaire height is not adjustable on site (micro-adjustments only)
- Available for slanted ceiling - 45° or less
- Canopy total minimum height (ceiling to top of canopy) - 6" / 15 cm
- Canopy total maximum height (ceiling to top of canopy) - 120" / 305 cm (120" provided), contact Lambert & Fils for more options
- Canopy height is adjustable on site

OFFSET MOUNTED (for slanted ceiling or offset canopy)

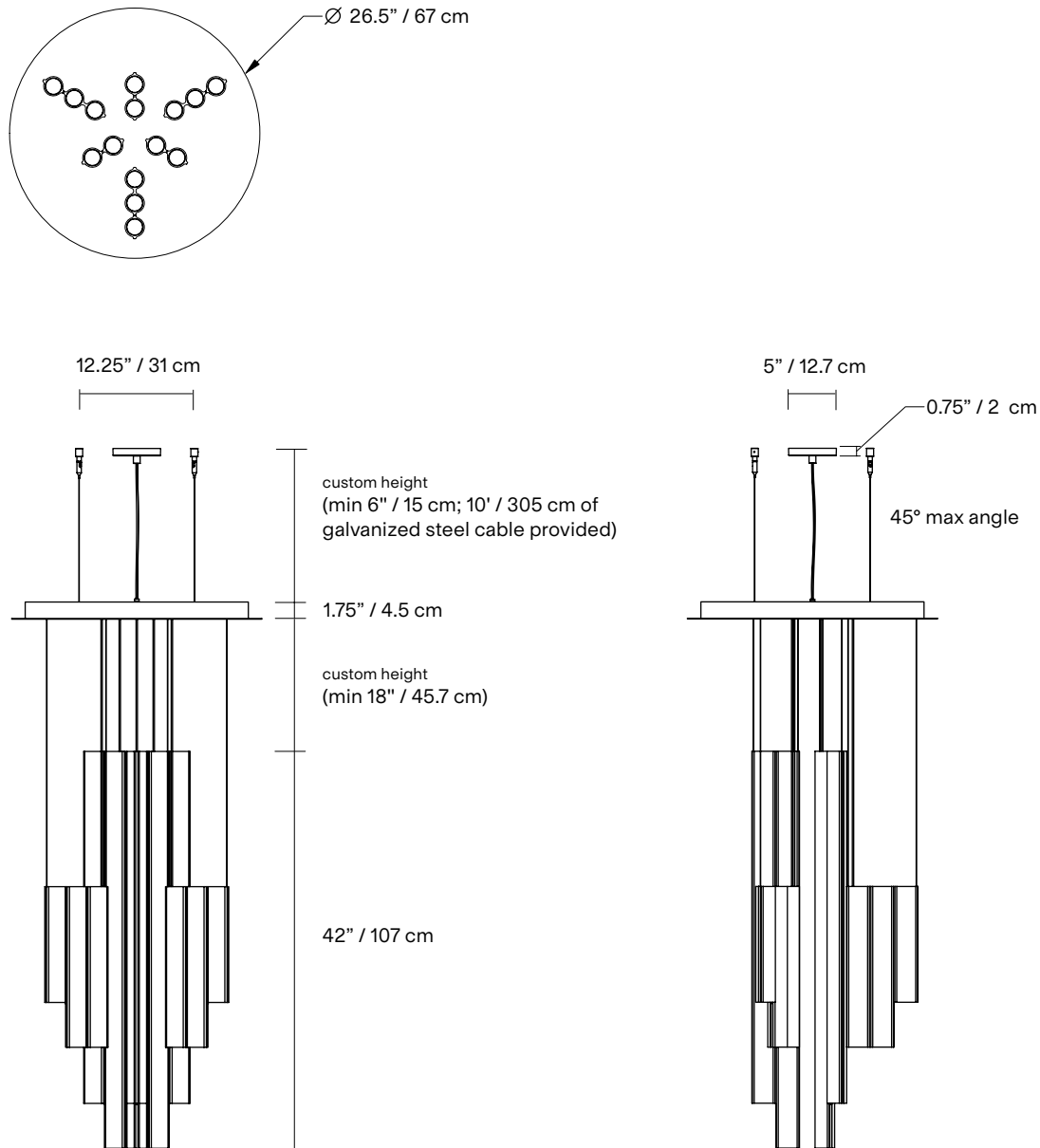

*dimensions are approximate and may vary slightly

FINISH



OB
Glossy
oxblood



MR
Mirror
polished
aluminum



BG
Textured
beige

CORD



BK
Black



WH
White



CU
Cumin

CANOPY AND MOUNTING SYSTEM

(offset canopy and anchors)



WH
Textured
white

NOTES

- Must be installed by an electrician
- LED may only be changed by Lambert & Fils or other authorized personnel
- Not protected against liquids (refer to IP20)
- Additional charges for modifications or for special orders
- Please refer to maintenance sheet on our website for cleaning instructions

LAMP ANATOMY

(Offset canopy)

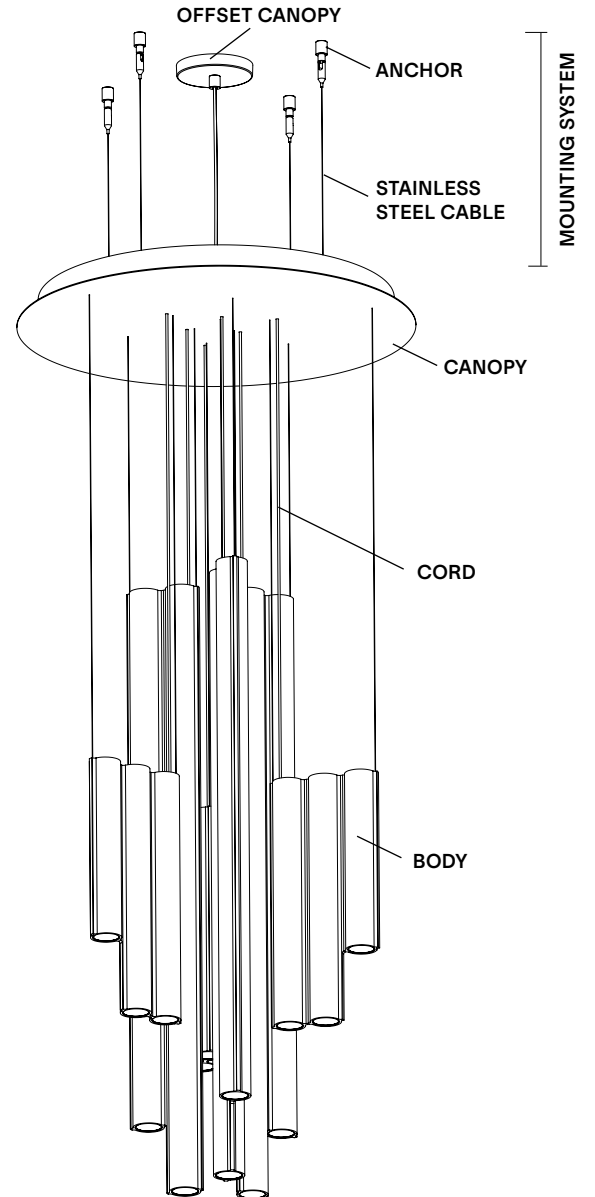
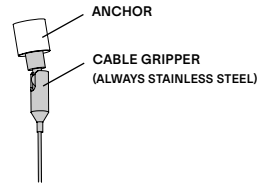

		Example	Fill with your selection
COLLECTION	SIL Silo	SIL	SIL
MODEL	52	52	52
BODIES	BG Textured beige OB Glossy oxblood MR Mirror polished aluminum CC Custom colour*	OB	
CORD	BK Black WH White CU Cumin	BK	
CANOPY	WH Textured white CC Custom colour*	WH	
MOUNTING TYPE	SM Surface mounted OS Offset mounted	SM	
MOUNTING TYPE FINISH**	WH Textured white CC Custom colour*	WH	
COLOUR TEMPERATURE (CCT)	WL Warm light (2700K) NL Neutral light (3000K) D27 Dim to warm (2700K-2200K) D30 Dim to warm (3000K-2200K) CCT Other CCT available upon request***	WL	
DIMMING	ZT 0-10V (120VAC only) PH Phase dimming DA DALI (220-240VAC only)	ZT	
FULL SKU		SIL52OBBKWHSMWLZT	

NOTES

*Custom colour available upon request. Material library on website.





**To choose only with offset mounted option.

***Specific CCT selection only available in 100k increments, from 2200K to 4000K inclusively and not available with Dim-to-Warm feature.

Silo Atelier 03



The Silo collection inhabits many worlds at once, creating a striking metaphor for duality. Mysterious yet inviting, the true magic lies in how its rhythmic curves shape light and space around it. Made using custom aluminum extrusions, the modular design creates a theatrical yet sleek composition.

TYPE	Suspension
CONSTRUCTION	Powder coated or mirror polished aluminum body Powder coated canopy Polycarbonate lens Polyurethane cord
SPECIFICATIONS	Source: LED array, integrated Power consumption: 44.5W Colour temperature: 3000K 2700K dim to warm 3000K to 2200K dim to warm 2700K to 2200K Lumen output: 3000K - 1585 lm 2700K - 1511 lm Colour rendering index: ≥90 CRI Colour consistency: 3 SDCM Expected lifetime: ≥50 000h
CONTROL	120/277V on/off, 0-10V, or phase dimming (120V only) 220-240V: On/Off, Phase Dimming, DALI
CORD LENGTH	Custom length
STAINLESS STEEL CABLE	Custom length
WEIGHT	59.5 lb / 27 kg
CERTIFICATIONS	     IP20
WARRANTY	2 years

NOTES

- Luminaire total minimum height (ceiling to lowest point of luminaire) - 48" / 122 cm
- Luminaire total maximum height (ceiling to lowest point of luminaire) - variable, please specify
- Luminaire height is not adjustable on site (micro-adjustments only)
- Not available for slanted ceilings (see offset mounted)

SURFACE MOUNTED

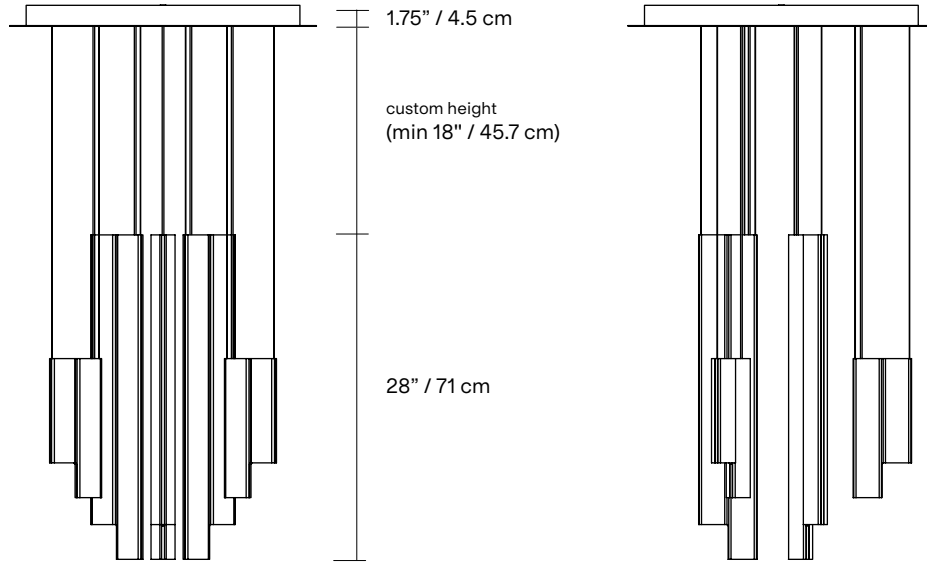
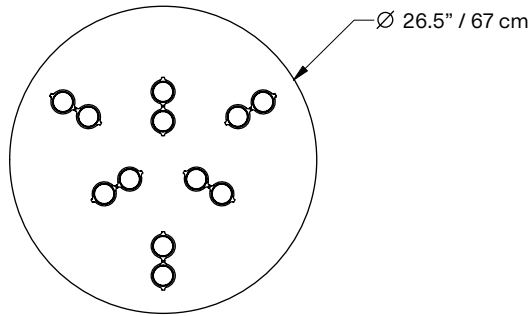

*dimensions are approximate and may vary slightly

Suggested installation

NOTES

- Luminaire total minimum height (ceiling to lowest point of luminaire) - 48" / 122 cm
- Luminaire total maximum height (ceiling to lowest point of luminaire) - variable, please specify
- Luminaire height is not adjustable on site (micro-adjustments only)
- Available for slanted ceiling - 45° or less
- Canopy total minimum height (ceiling to top of canopy) - 6" / 15 cm
- Canopy total maximum height (ceiling to top of canopy) - 120" / 305 cm (120" provided), contact Lambert & Fils for more options
- Canopy height is adjustable on site

OFFSET MOUNTED
(for slanted ceiling
or offset canopy)

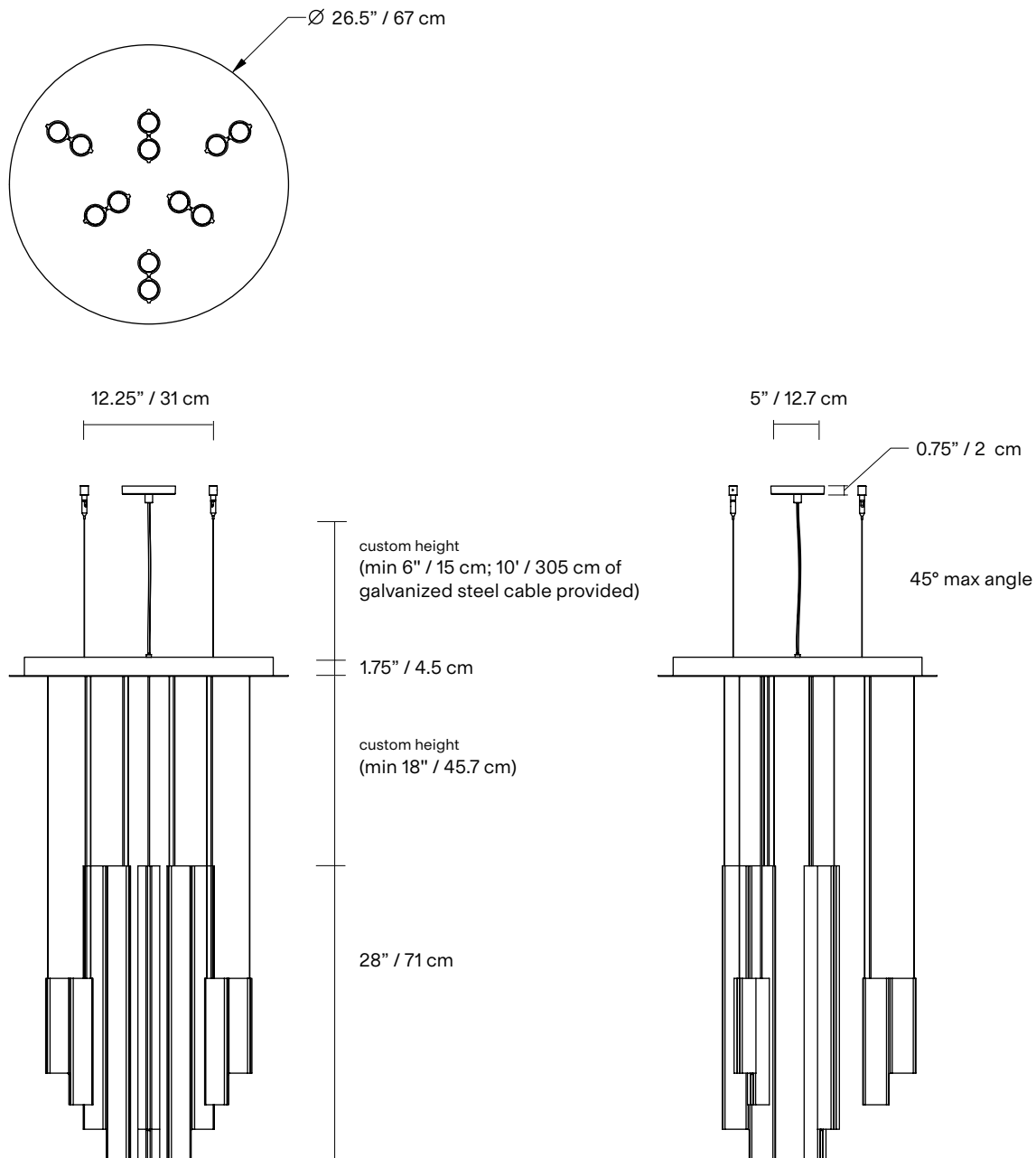

*dimensions are approximate and may vary slightly

FINISH



OB
Glossy
oxblood



MR
Mirror
polished
aluminum



BG
Textured
beige

CORD



BK
Black



WH
White



CU
Cumin

CANOPY AND MOUNTING SYSTEM

(offset canopy and anchors)



WH
Textured
white

NOTES

- Must be installed by an electrician
- LED may only be changed by Lambert & Fils or other authorized personnel
- Not protected against liquids (refer to IP20)
- Additional charges for modifications or for special orders
- Please refer to maintenance sheet on our website for cleaning instructions

LAMP ANATOMY

(Offset canopy)

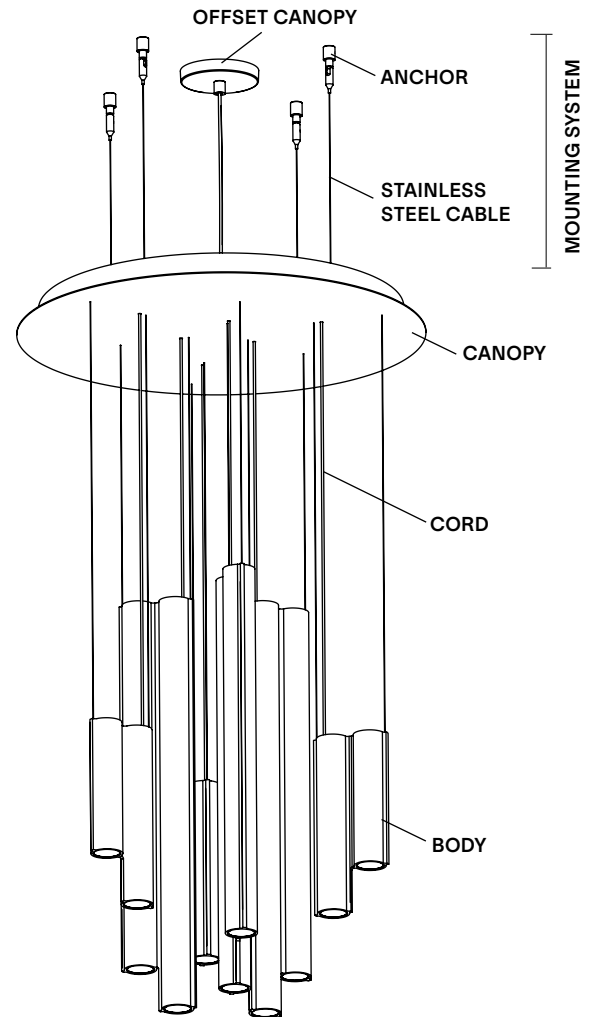
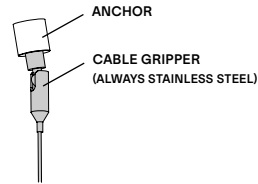

		Example	Fill with your selection
COLLECTION	SIL Silo	SIL	SIL
MODEL	53	53	53
BODIES	BG Textured beige OB Glossy oxblood MR Mirror polished aluminum CC Custom colour*	OB	
CORD	BK Black WH White CU Cumin	BK	
CANOPY	WH Textured white CC Custom colour*	WH	
MOUNTING TYPE	SM Surface mounted OS Offset mounted	SM	
MOUNTING TYPE FINISH**	WH Textured white CC Custom colour*	WH	
COLOUR TEMPERATURE (CCT)	WL Warm light (2700K) NL Neutral light (3000K) D27 Dim to warm (2700K-2200K) D30 Dim to warm (3000K-2200K) CCT Other CCT available upon request***	WL	
DIMMING	ZT 0-10V (120VAC only) PH Phase dimming DA DALI (220-240VAC only)	ZT	
FULL SKU		SIL53OBBKWHSMWLZT	

NOTES

*Custom colour available upon request. Material library on website.

**To choose only with offset mounted option.

***Specific CCT selection only available in 100k increments, from 2200K to 4000K inclusively and not available with Dim-to-Warm feature.