

CONTENTS

Fixture (x1)

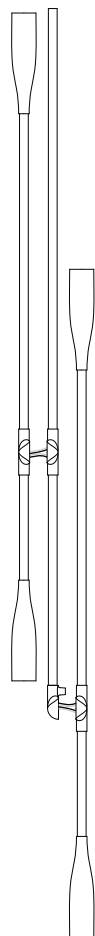

Canopy Assembly (x1)

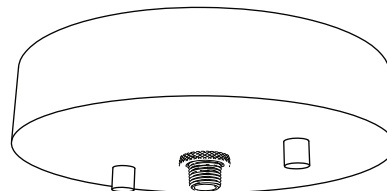

#8-32 Screws (x2)



Hang-Straight (x1)



Thumb Screw (x2)



SAFETY INFORMATION

Please contact a licensed electrician for installation.

Suitable for dry, indoor use.

Do not use bulbs that exceed 100 watts.

Note that the fixture arrives folded and wrapped in protective packaging. Envelope(s) attached to the exterior of the wrapped fixture(s) contain the Thumb Screw(s). Where possible, the fixture may be easier to install while in the folded and wrapped positioned, and unwarppd after installation, so the extended arms are not getting in the way of the installation process.

CEILING INSTALLATION

1] Unscrew the Mounting Caps (E) to detach the Mounting Plate (A) from the back of the Canopy Assembly.

2] Secure the Mounting Plate (A) onto the junction box using the provided #8-32 Screws (C).

3] Run the wires through the Hang-Straight (G) and screw the Hang-Straight to the top of the Fixture Drop (H).

If your order includes additional drop rod lengths, run the wires through the additional lengths and screw together the multiple lengths before running the wires through the Hang-Straight.

4] Run the wires up through the Canopy Nipple (F) and screw the Canopy to the top of the Hang-Straight (G). Secure this assembly by tightening the lock nuts inside the Canopy.

5] Make the wire connections from the junction box wires to the Fixture while carefully holding the Fixture. Attach the green ground wires to the Mounting Plate (A) with the provided green ground screw.

6] Tuck the connected wires into the junction box. Raise the Canopy (D) until the Threaded Posts (B) come through the holes in the Canopy. Press the Canopy flush to the ceiling and secure in place with the Mounting Caps (E).

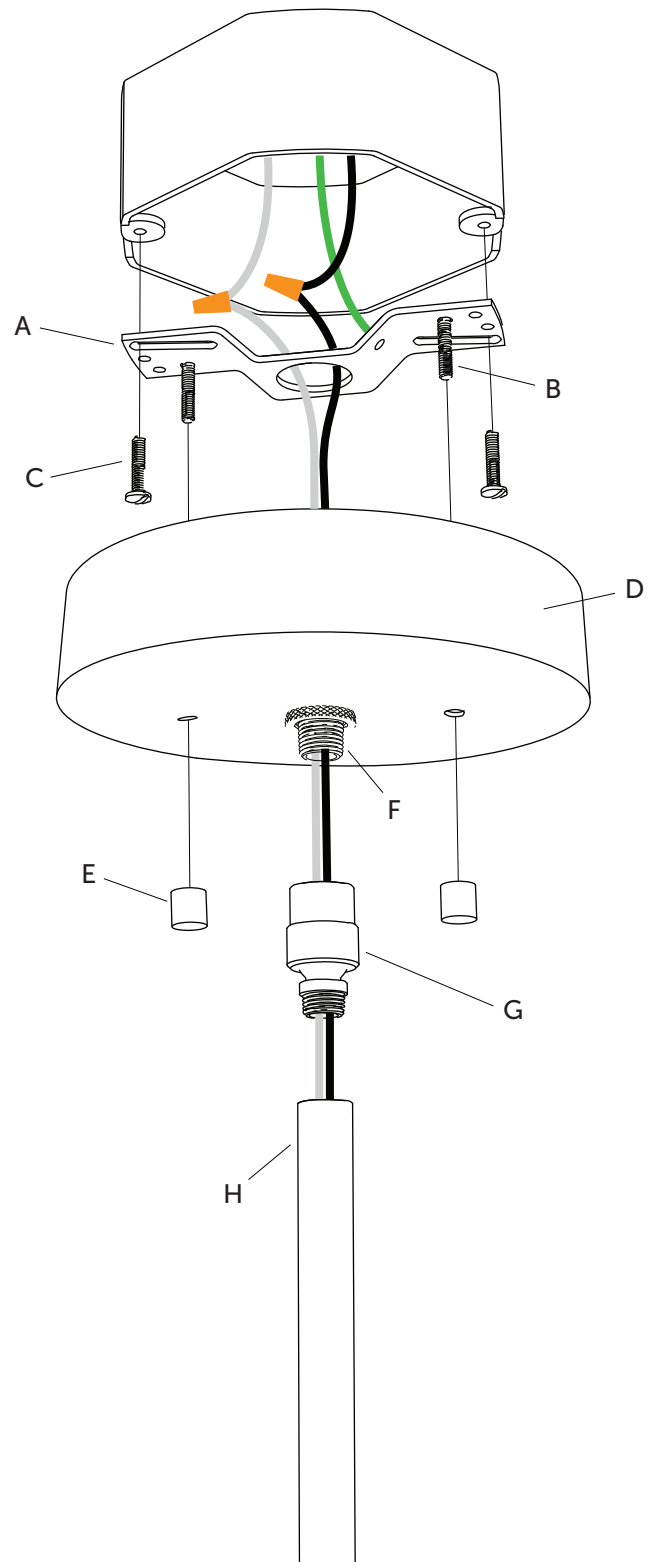

POSITIONING & ADJUSTMENTS

To secure the Arm (J) of the fixture, pass the Thumb Screw (M) through the hole in the Single Joint (L) and into the threaded portion of the Double Joint (K) until the Arm is secured.

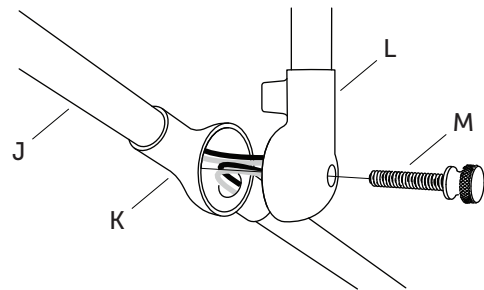

To adjust the Arm angle (vertical plane), loosen the Thumb Screw while holding the Arm of the light. Adjust to the desired angle and secure in place by tightening the Thumb Screw.

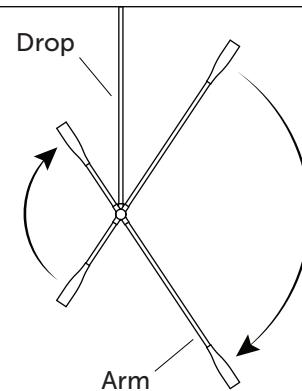

To adjust the Arm angle (horizontal plane), starting with the highest Arm, hold the Drop Rod just above the Joint. With your other hand, grasp the Joint and rotate it and the Arm clockwise around the Internal Threaded Nipple. DO NOT rotate the Joint more than 360° as this may cause damage to the internal wiring.

For drops with more than one Arm, this adjustment will likely cause the Arms below to rotate as well, so start with the highest Arm and work your way down the fixture until the desired positions have been achieved.

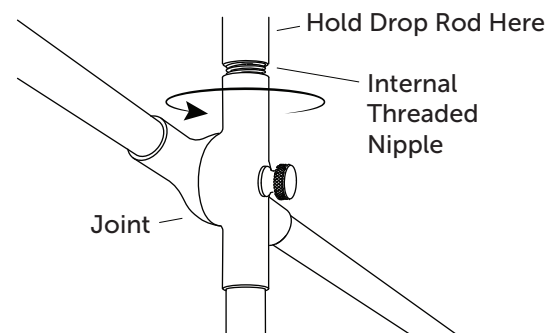

The Hang-Straight hardware allows for the fixture to be rotated and adjusted to hang straight.

IMPORTANT: The Hang-Straight hardware is meant for positioning **ONLY** and is not suitable for continuous use. Over use or over rotation can cause a short in the wiring and electrical shock.

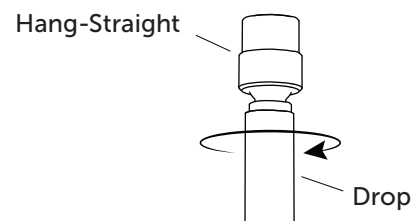

Screw in bulbs fully. If bulb is not fully screwed in, it may appear to sag or be crooked. Though do not over tighten.

If the bulbs looks crooked after screwing in fully, push gently near the base to correct.

