

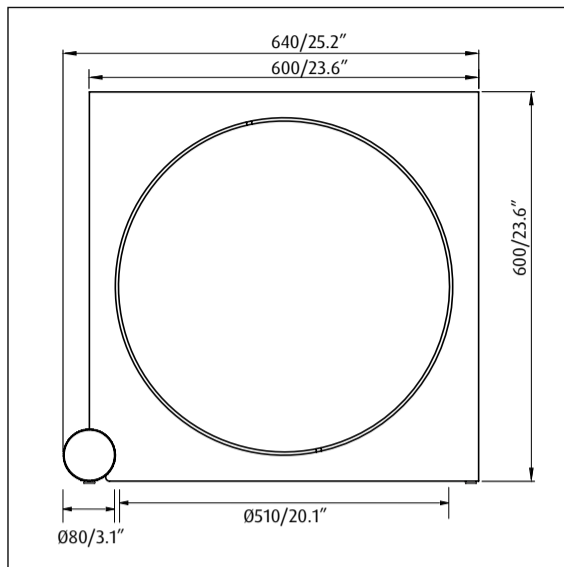





Moonsetter

Design Anne Boysen



28100-11

Light source	Voltage	Weight	Ingress protection
LED 19W  	AC100-240V, 50/60HZ	20,5 kg / 45.2 Lbs	IP20 / Dry location
LED 19W  	DC 24V  SELV	20,5 kg / 45.2 Lbs	IP20 / Dry location

Recommended cleaning substances:

Wipe off dust with a dry, soft cloth. Remove greasy spots etc. with a soft cloth dampened in lukewarm water (<122° F/ 50° C) with a mild detergent.

If you use a soft cloth dampened in lukewarm water please remember to wipe the lamp with a dry cloth.

Do not use thick polish products.

Warning: Scouring powder and similar substances will scratch surfaces.

All installation is subject to local code and jurisdiction.

 Due to possibility of personal injury or property damage, always contact a qualified electrician for servicing or repair of this fixture. To avoid risk of electrical shock, personal injury, or death, disconnect power to fixture before servicing.

This lamp is only suitable for placement on the floor, not on tables or other surfaces.

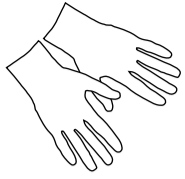

! ID NUMBER: _____
Please register ID number at www.louispoulsen.com

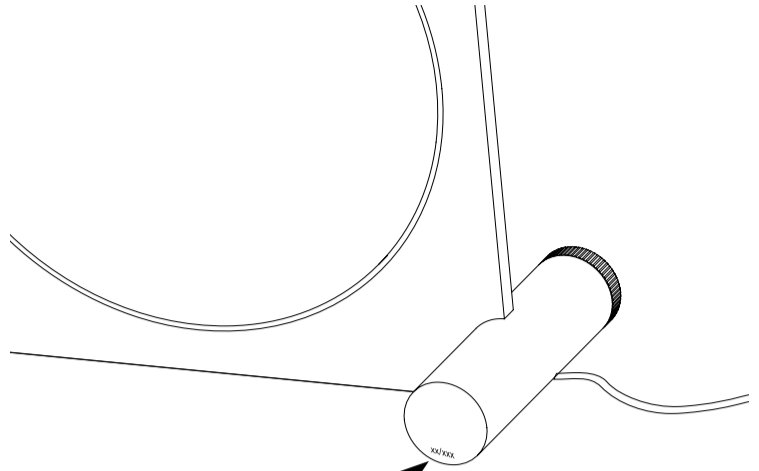

LIMITED EDITION
XX/XXX

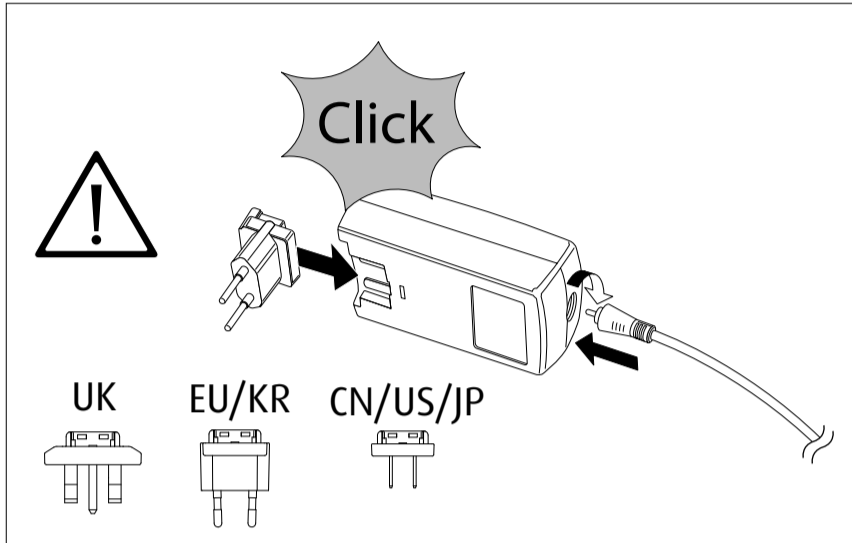

! WARNING - Pinch/Crush Hazard"

